

NOTE 1 ALTERNATE MARKING: STICKER OR STAMP

F4	46083	ISO-G 1 1/4 INT HEX, TH = 27,1	CD000318
F3	46083	ISO-G 1 1/4 INT HEX, TH = 27,1	CD000318
F2	46083	ISO-G 1 1/4 INT HEX, TH = 27,1	CD000318
F1	46083	ISO-G 1 1/4 INT HEX, TH = 27,1	CD000318

Pos	Article No	Title / Denomination, code, material, dimension etc	Drawing No./ref	Pos	Article No	Title / Denomination, code, material, dimension etc	Drawing No./ref
-----	------------	---	-----------------	-----	------------	---	-----------------

Title		B16H/1P-SC-S	
	Created Date	2025-01-04	Created By
	Article/Configuration number	074633.0	Drawing number
		AU	
		AU00075578_074633.0	

Rev No	Alteration	Date	Checked	Approved
05	ADDED DIMENSION	23. 1. 2013	SKZE	BOS

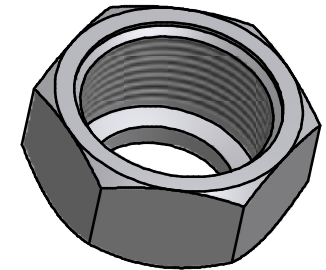
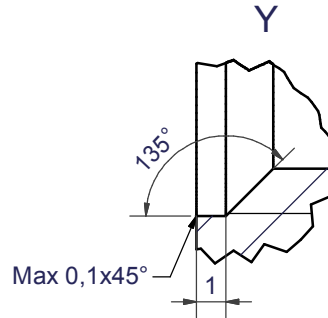
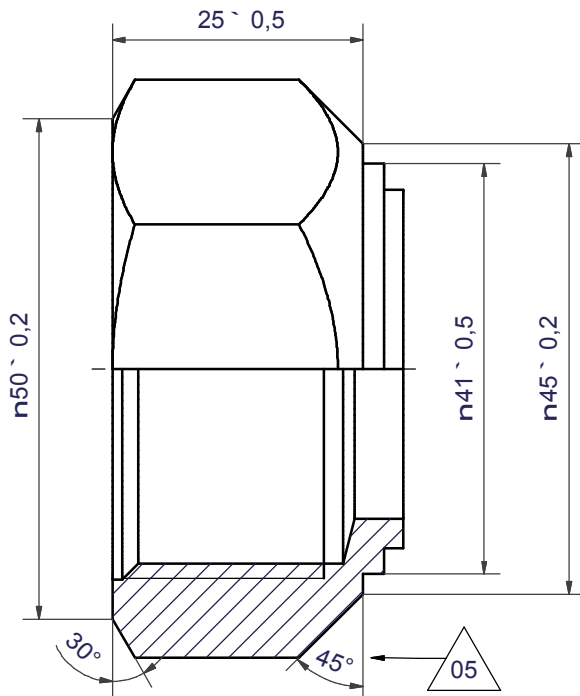
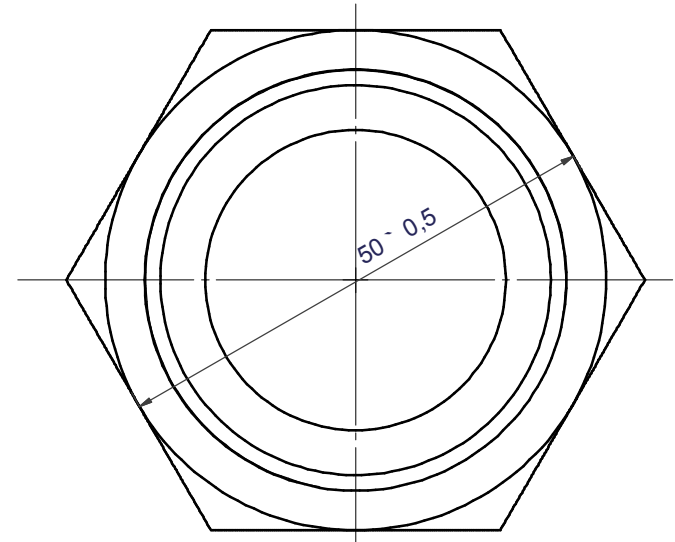
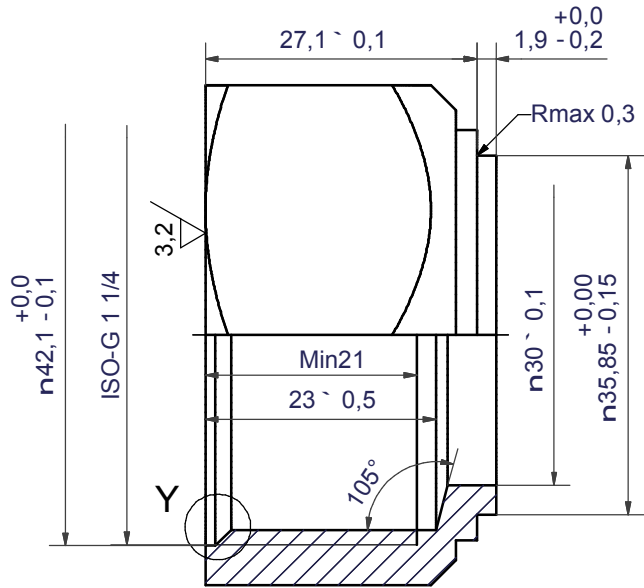

DEBURR SHARP EDGES; MAX 0.4

ACCORDING TO MQS
MATERIAL

Drawn EG	Checked TOD	Approved BOS	Created Date 12. 2. 1997	General geometrical tolerancing ISO 2768 m	General surface finish R _a 3.2	Scale -	Paper size A3
 A DOVER COMPANY			Title ISO-G 1 1/4 INT HEX				
			Article / Tool number CD	Design Type CD	Drawing number CD000318	Revision 05	Sheet 1 (1)